

Section E. Appendix On Street Dining Guidelines and Specifications



Table of Contents

1	Introduction	3
2	Dining Furniture	7
3	Screen Fence	8
4	Bollards	11
5	Shade Structures	12
6	Maintenance & Management of the on street dining area	13
7	Areas not suitable for on street dining	13
8	Application Process	14
9	Construction of Works	14
10	Annual Licence	15
11	Termination	15

1. Introduction

1.1 Purpose of the Guidelines

These guidelines have been developed to maintain the balance between pedestrian safety and access whilst utilising public roads, streets, lanes, footpaths and malls for On-Street Dining. It provides simple urban design guidelines and acceptable solutions for On-Street Dining activities. The distances and specifications are based on Best Practice and should be adhered to wherever possible, however, Council acknowledges that on occasion this may not be possible and will work with businesses to find a suitable solution.

These guidelines have also taken into consideration the requirements of the *Commonwealth of Australia Disability Discrimination Act 1992*, *Commonwealth of Australia Disability [Access to Premises - Buildings] Standards 2010* and the *Tasmania Anti - Discrimination Act 1998*. The Guidelines have also been developed in conjunction with a Disability Discrimination Act compliance consultant.

These Guidelines must be read in conjunction with Council's On-Street Dining Policy (18-Plx-011) and Goods on Footpath Guidelines and Specifications (18-Rfx-034), which can be obtained by contacting Council's Customer Service Centre on (03) 6323 3000 or accessing Council's website: www.launceston.tas.gov.au

1.2 Guideline application areas

These On-Street Dining Guidelines apply to all public roads, streets, lanes, footpaths and malls across the entire municipality of Launceston.

The Licensee is responsible for ensuring the Guidelines are adhered to at all times.

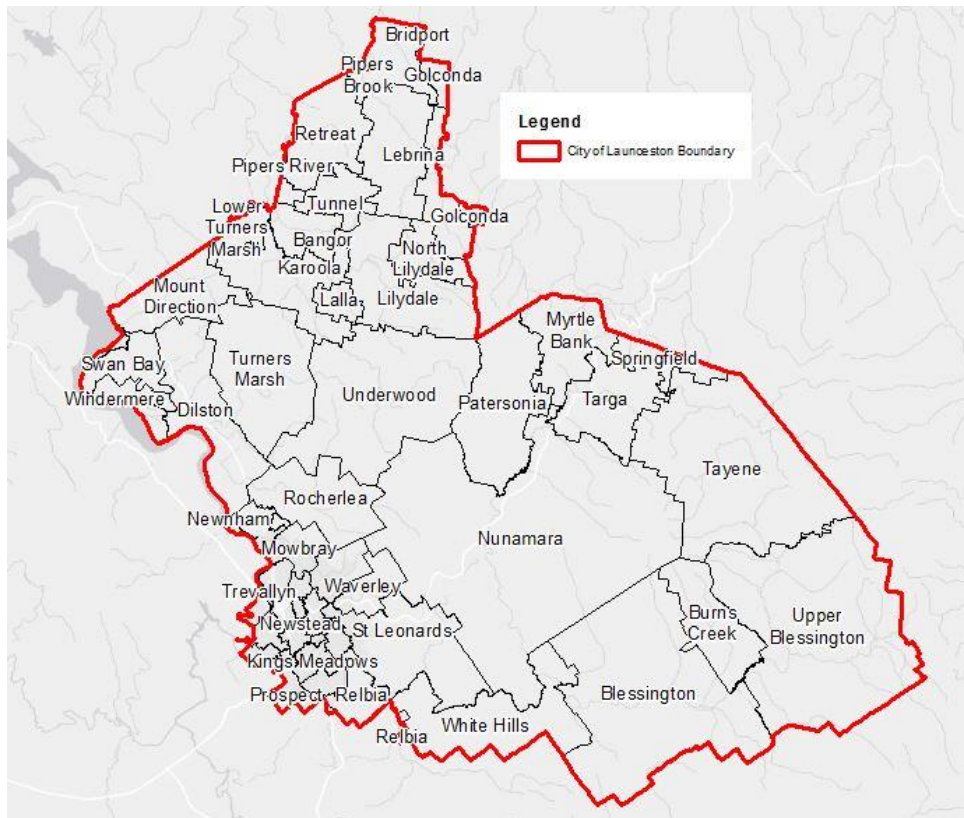

1.3 Definitions

(To be read in conjunction with definitions in the On-Street Dining Policy 18-Plx-011)

Council

The City of Launceston.

Business

Any commercial activity including but not limited to retail or wholesale of goods, restaurants, amusement centres, nightclubs, or the delivery of a service or exchange, etc.

Footpath

An area open to the public that is designated for, or has as one of its main uses, use by pedestrians.

Mall

A mall under the control of the City of Launceston, including but not limited to Brisbane Street Mall, the Quadrant Mall and Civic Square.

On-Street Dining

The provision of chairs and table structures for use by customers of an adjoining food serving premises.

On-Street dining activities

The consumption of food and or beverages by seated customers in an area on a highway external to a shop or restaurant and managed by that shop or restaurant.

Property Line

The line that defines the boundary between the road reserve and private property.

Pedestrian Areas

Is defined between the property boundary and the utility zone, and is known as the access zone. Also includes malls, avenues and any other public road reserve / footpaths defined by the Director Infrastructure Services.

Licence

A pavement encroachment licence issued by the Council in accordance with these Guidelines.

Authorised officer

A person employed by the Council in the position of Director Infrastructure Services or a Regulations Officer.

Waste bins

A receptacle provided for the disposal of single service food containers and implements for use by patrons using the licenced area.

Kerbside Clearance

The measurement taken from the face of kerb to any street furniture or street infrastructure.

Applicant

The person or person's applying for the On-Street dining application.

Licensee

The person or person's who have received an approved application for On-Street Dining.

1.4 Streetscape

Clear property Lines:

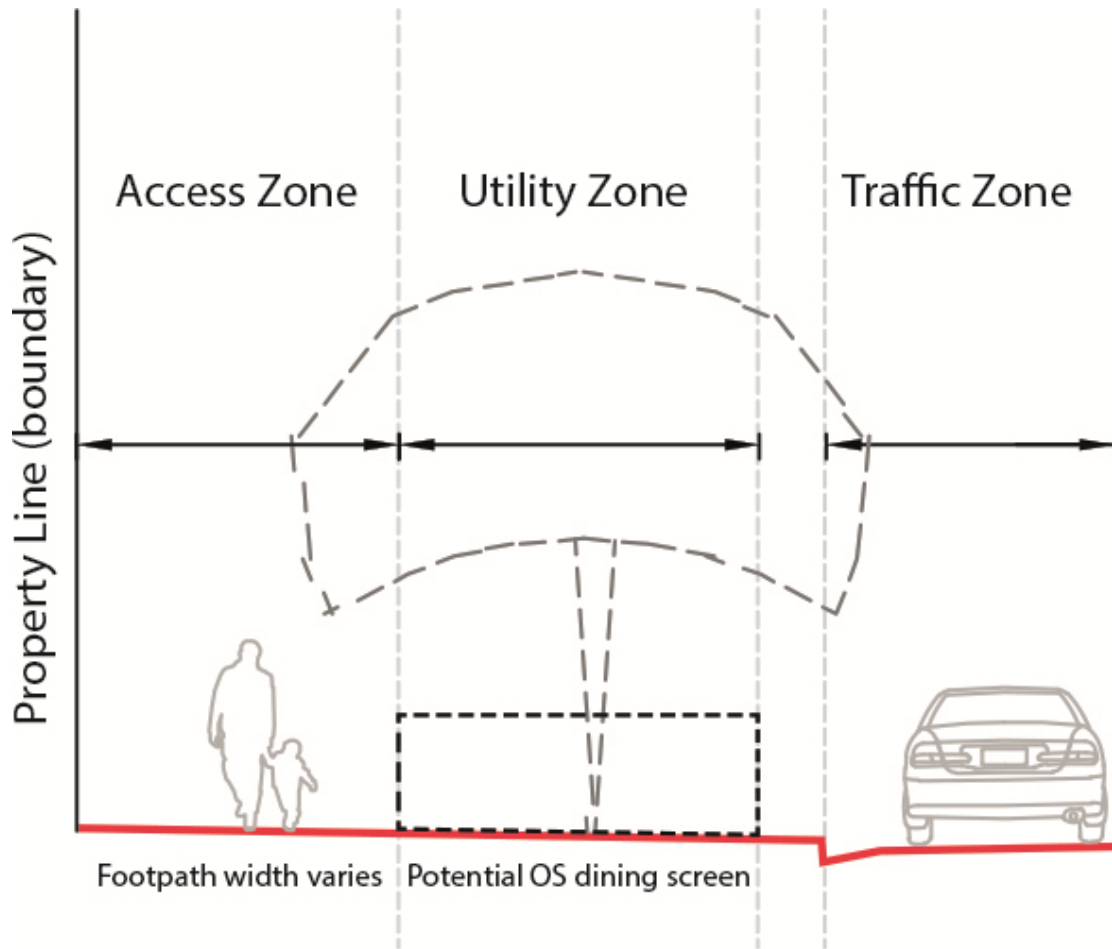

TYPICAL SECTION ON-STREET DINING

2. Dining Furniture

Where there is existing Council infrastructure preventing the potential use of On-Street Dining activities, Council will consider covering the costs associated with the removal or relocation of the infrastructure. Requests for removal or relocation of infrastructure will be considered on a case by case basis.

2.1 Dining Furniture

Includes tables, chairs, screen fences, umbrellas, portable heaters and the like.

2.2 Design of Dining Furniture

The design of dining furniture must include the following:

- All legs or points of contact must be designed to prevent damage to footpath paving.
- Where kerbside parking occurs a screen fence must be installed.
- Advertising logos or signs are permitted on furniture. However, prior approval is required.

2.3 Placement of Dining Furniture

The dining furniture must be placed so that:

- It is retained within the area approved in the licence issued by the Council.
- The clearance between any part of the dining furniture and the property line (i.e. shopfront) is as follows:-
 - 2500mm minimum - Brisbane Street (between St John Street and George Street); and the Brisbane Street Mall;
 - 1800mm minimum - other CBD streets being Charles, St John and George Streets (between York and Paterson Streets); York and Paterson Streets (between Charles and George Streets); and the Quadrant Mall;
 - 1500mm minimum elsewhere; or
 - any greater clearance as specified in the licence.
- It is recommended that diners are at least 500mm clear of any bollard (erected as required by Section 4).
- For tree plots, bollards, poles and other similar objects a 500mm clearance is recommended.
- It is recommended no furniture is to be placed within 1000mm of any parking meter or other street furniture or street tree.

In addition:

- On-Street Dining is not permitted where loading zones, bus stops, taxi ranks or road crossing points are directly situated in front of the business.

- Consultation with the Council's Planning Department must be undertaken to ensure the application proposal fits with heritage values.

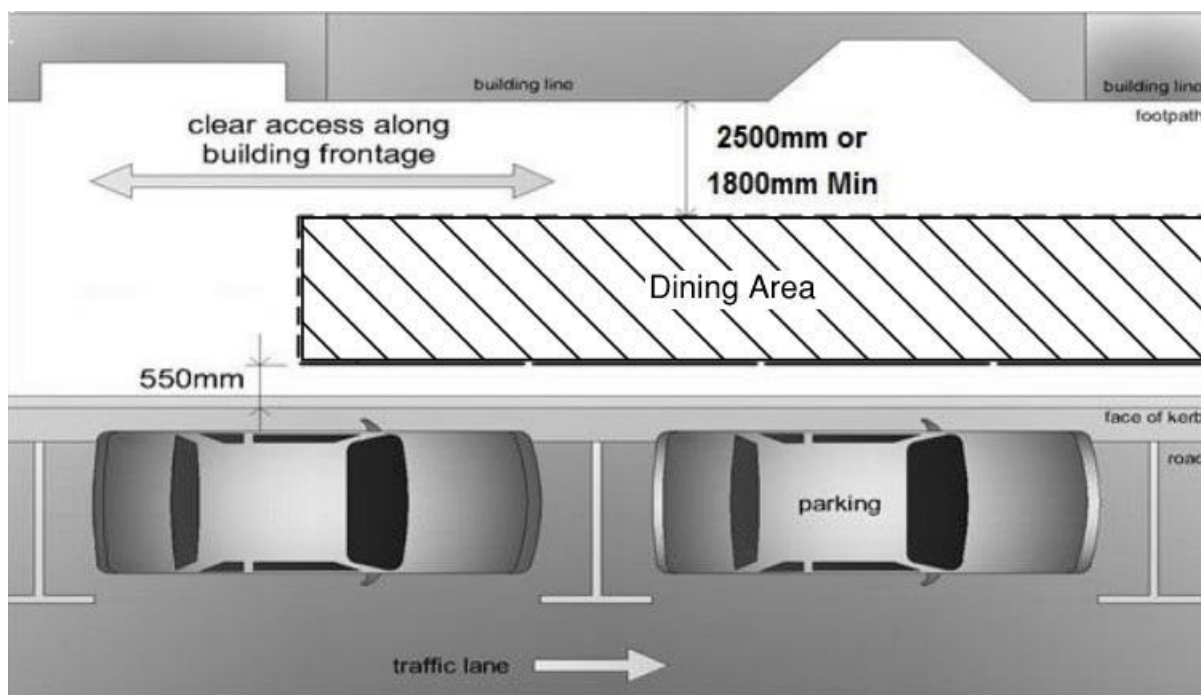

2.4 General

- The dining furniture shall remain the property of the licensee.
- Additional signage or Front of Shop Modules (FoSMs) are to be approved at the discretion of Environmental Services. Please refer to the Goods on Footpaths Guidelines and Specifications (18-Rfx-034) and Portable Signs Guidelines and Specifications (18-Rfx-035).

2.5 All furniture must be kept within the Utility Zone during business hours and removed at the end of day trading by the licence holder.

3. Screen Fencing

3.1 Screen fencing may be either:

- free standing; or
- if used in conjunction with fixed bollards the fencing may fit within 25mm wide cleats welded or fixed to the bollards - provided there are no sharp edges and that they are not otherwise a danger to pedestrians.

A minor intrusion of a dining area in front of an adjacent premise if approved by both the occupier and the owner may be approved by Infrastructure Services.

3.2 Glass Screens

Glass screens are recommended in heritage areas. The recommended height for glass screens is between 900mm and 1500mm. A glass screen cannot exceed 1500mm.

Glass screens shall be designed to *Australian Standard 1170.1 Structural design actions* for balustrades, and permanently fixed to the pavement.

Advertising logo's or signs may be placed on alternate glass screens, provided they are displayed using frosted glass and are no larger than 250mm by 250mm.

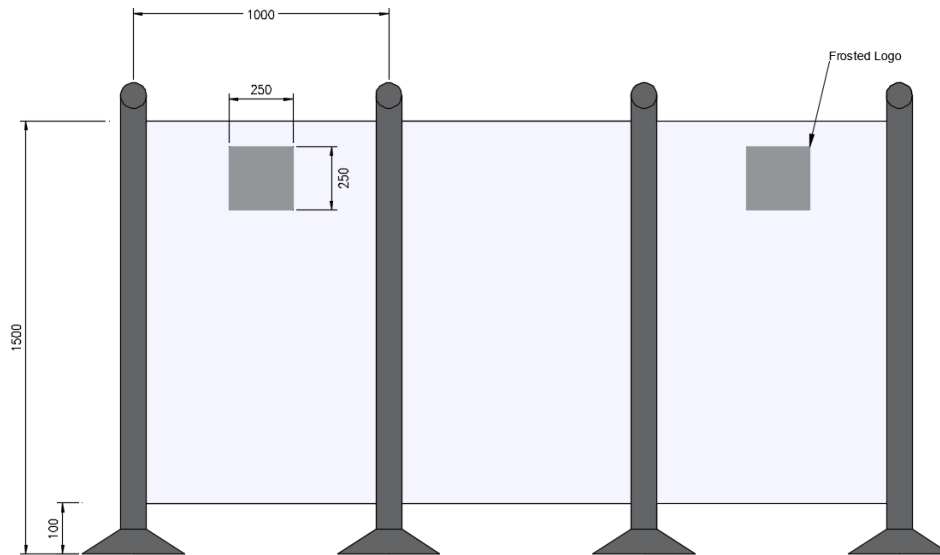

3.3 Opaque Screens

Opaque screens should have a lightweight frame and be secured with sandbags or other approved weight systems to ensure they cannot collapse and cause injury or become an obstacle. An opaque screen cannot exceed 900mm.

Temporary opaque screens must be removed at close of business.

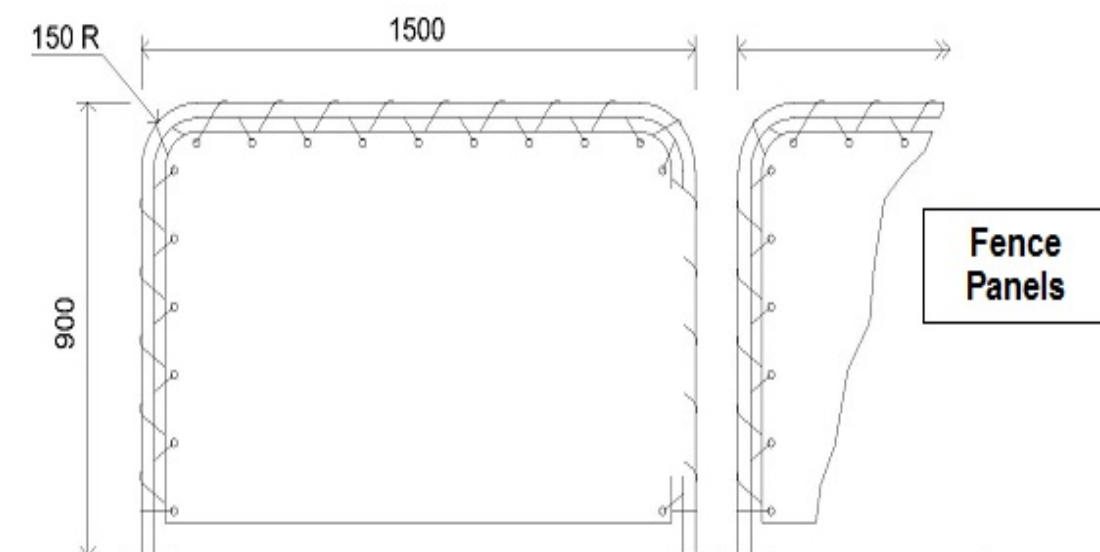

3.4 Screen Fencing must be:

- used if the On-Street Dining area is adjacent to kerbside parking;
- along the same alignments as any existing bollards;
- used between separately licenced On-Street Dining areas;
- temporary fencing must be removed at close of business; and
- no closer than 550mm to the face of kerb to allow for access to parked cars, except in the case of a Disability Parking bay being located near the On-Street Dining, in which case appropriate distances as per the Australian Standard 2890.6 must be adhered to.

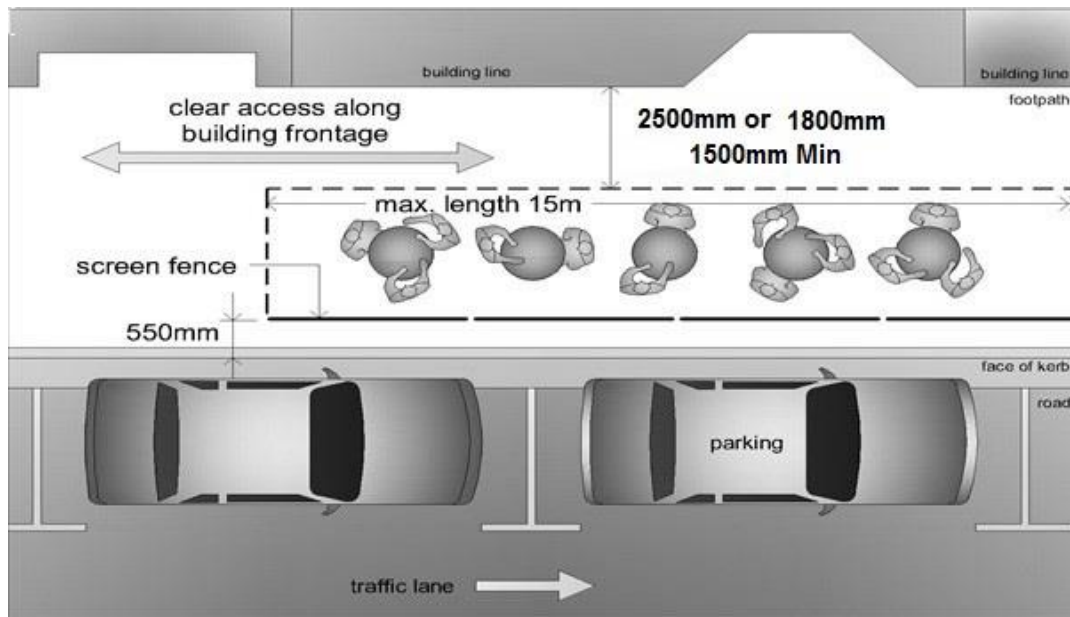

- 3.5** The On-Street Dining Licensee shall monitor the dining area frequently to ensure that screen fences are not a hazard to pedestrians or motorists.

4. Bollards

4.1 Bollards are used to improve the safety of patrons dining near traffic lanes. They **must** be used when the dining area is directly adjacent to traffic lanes - including turning lanes (i.e. where there is no on-street parking).

4.2 New installations of bollards must:

- be spaced to not exceed 1500mm - Note: If specified in the licence issued by the Council, the gap may be reduced to 1200mm in situations to protect against on-coming traffic;
- where adjacent to traffic lanes a kerbside clearance of 300mm is required;
- where adjacent to parking bays a kerbside clearance of 550mm is required; and
- 500mm clearance is recommended between diners and any bollards.

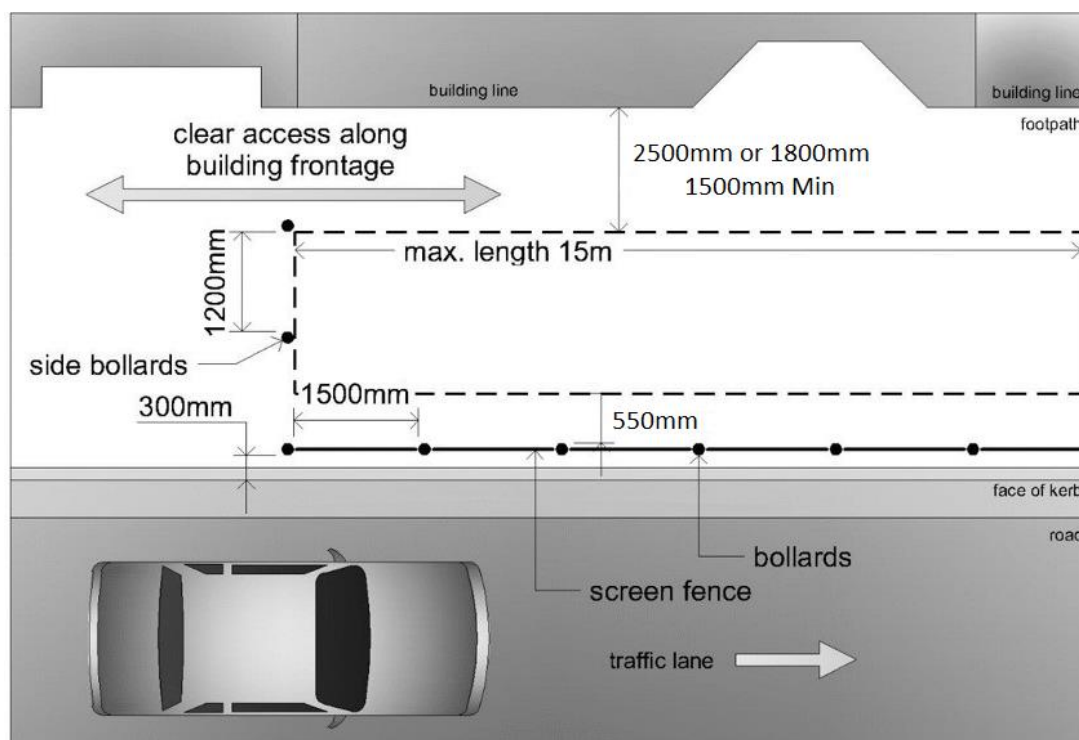

4.3 The supply and construction of the bollards shall be the responsibility and at the expense of the licensee, and shall:

- Comply with the Local Government Association of Tasmania Standard Drawings - TSD-R31.v1. (However in critical situations the bollard type and construction may be required to comply with the Australian Standard for Crash testing).
- Be constructed, and approved by the Council's Authorised Officer, before use of the dining area and will become the property of the Council.
- All temporary bollards must be removed at close of business.

5. Shade Structures

5.1 Shade Structures include free standing awnings, fixed umbrellas and the like. Any shade structure used must be within Australian Standards and be set up according to manufacturer's specifications.

5.2 Design and placement of shade structures

- Shade structures must have a minimum height above footpath level of 2.2 metres with a maximum height of 2.4 metres.
- The edge of any awning must be set back at least 550mm from the face of kerb.
- Footings must be set back at least 550mm from the face of kerb.
- Footings are to be located clear of underground services and shall be owned by the Council.
- The supply and construction of the footings shall be the responsibility and the expense of the licensee.
- The fixings of an umbrella shall be in accordance with the manufacturers recommendations appropriate to the wind speed. Any permanent fixtures are to be approved by Council.

5.3 All shade structures must be removed or lowered if weather renders them potentially unsafe and at close of business.

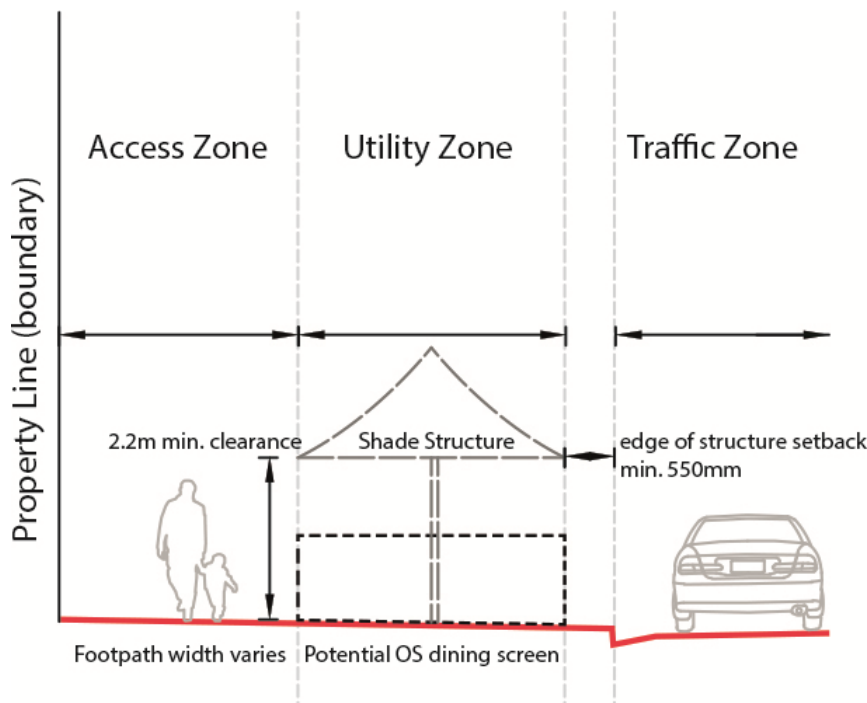

TYPICAL SECTION ON-STREET DINING - SHADE STRUCTURES

6. Maintenance and Management of the On-Street Dining Area

- 6.1** The licensee must maintain the area where the licence applies and the area adjacent to it in a clean and sanitary manner. This includes: emptying waste bins, washing pavements on a daily basis, immediately cleaning and washing away any liquid, food, debris, broken glass, cigarette butts or waste from the area.
- 6.2** A licensee must not use existing street rubbish bins for the disposal of waste.
- 6.3** Any dining furniture (including tables, chairs, screen fences, umbrellas, portable heaters and the like) shall be removed or re-positioned if they are or likely to be a danger to pedestrians or traffic.
- 6.4** All licenced On-Street Dining areas are smoke-free zones. It is the responsibility of the licensee to ensure that all customers comply with this requirement.

7. Areas not suitable for On-Street Dining

- 7.1** On-Street Dining will be prohibited:
- Where it blocks sight distance on street corners or where significant driveways enter a road (significant driveway is a driveway that is estimated to carry 40 or more traffic movements per day);
 - Where it blocks sight distance to pedestrian crossing points;
 - Adjacent to bus stops, loading zones or taxi ranks;
 - Where there are significant trip hazards due to drainage channels, steps or changes in levels;
 - Where it reduces pedestrian paths to less than specified in Section 2.3;
 - Where the business does not have good visual contact or good ability to adequately monitor the potential on-street dining area; and
 - Where the business is unable to comply with the Building Code of Australia's toilet provisions.
- 7.2** The business must be conducted in a manner that does not restrict pedestrian access on the footpath, for example operating from an opening onto the footpath.

8. Application Process

8.1 To apply for an On-Street Dining Licence, please first ensure you are able to comply with the guidelines. Then you will need to complete an Application for On-Street Dining form (10-Fmx-025).

The form can be obtained:

In person: Customer Service Centre, Town Hall
St John Street, Launceston

By phone: (03) 6323 3000

Internet: www.launceston.tas.gov.au

8.2 A licence will be issued if the application is approved and upon receipt of:

- The annual licence fee (determined on the area of the On-Street Dining). An additional fee (equivalent to the loss of revenue) shall apply if the application includes the removal of street parking.
- Applicants should provide a copy of the Occupancy Certificate issued for the premises of which they are applying, to be included as part of the assessment for new applications or changes to the original application.
- An applicant must have public and products liability insurance cover of \$10 million. A Certificate of Currency that confirms this cover needs to be provided to the Council before the applicant can be issued with a licence. The Certificate of Currency must provide a clear statement that acknowledges that the insurer is aware of the extension to the business to include the On-Street Dining area.
- There is a licence fee associated with on street dining.

9. Construction of Works

9.1 If the approved application includes the construction of fixed works - such as bollards, insitu foundations, footpath pavement or kerb extensions, then the licensee must reach an agreement with Council for the construction of road works within a public road to improve a streetscape for On-Street Dining. The Council may require plans to be prepared prior to construction. The Contractor used must be approved by Council.

9.2 All works will be the responsibility and at the expense of the licensee.

9.3 Damage to Council Infrastructure

The licensee is liable for all costs associated with damage to Council infrastructure resulting from non-compliance with the conditions of the Planning Permit and any by-law or legislation relevant to the development activity on the site. The licensee will also be liable for all reasonable costs associated with the enforcement of compliance with the conditions, by-laws and legislation relevant to the development activity on the site.

10. Annual Licence

The licence shall receive a renewal invoice annually. All licences expire on the 31st December each year. A copy of the applicant's Public liability Certificate of Currency is to be forwarded to Council each year on renewal.

11. Termination

11.1 The Council may terminate the licence at any time if the licensee:

- Fails to maintain their premises in accordance with these guidelines and any condition attached to the licence.
- Fails to comply with a notice issued by an authorised officer to bring the premises into compliance.

11.2 Termination of the licence can only be undertaken by the Director Infrastructure Services.

PURPOSE

These guidelines have been developed to maintain the balance between pedestrian safety and access whilst utilising public footpaths or roads for On-Street Dining.

SCOPE

These guidelines apply to all businesses within the Launceston Municipality as per Section 1.2 of these guidelines.

RELATED POLICIES & PROCEDURES

- Draft 18-PI-011 On Street Trading Activities Policy
- 18-Rfx-034 Goods on Footpaths guidelines and Specifications
- 18-Rfx-035 Portable Signs Guidelines and Specifications

DOCUMENT INFORMATION

Reference number	18-Rfx-033
Version	27/08/2018
Review	27/08/2021
Key function	Land Use & Development
System	
Document type	High Level or Detail Procedure
Responsible Directorate	Infrastructure
Approved by	Manager Technical Services
Action Officer	Manager Spatial & Investigations
Text search key words	On street dining guidelines specifications

To be communicated to (To be identified by Approver) (Insert ✓ in relevant row)		Department/Area only
		Directorate via Director and Managers
	✓	Specific Areas:
	✓	• Spatial & Investigations
		• Development Services - Environmental Health
		Organisation-wide
✓		Website
		Intranet (via a link)

Hard copy distribution	N/A
-------------------------------	-----